

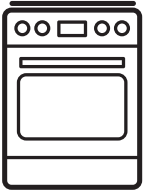

Electrolux



electrolux.com/register



LKR64440SW

EN User Manual | **Cooker**



Welcome to Electrolux! Thank you for choosing our appliance.



Get usage advice, brochures, trouble shooter, service and repair information:
www.electrolux.com/support

Subject to change without notice.

CONTENTS

1. SAFETY INFORMATION.....	2
2. SAFETY INSTRUCTIONS.....	5
3. INSTALLATION.....	7
4. PRODUCT DESCRIPTION.....	9
5. BEFORE FIRST USE.....	10
6. HOB - DAILY USE.....	11
7. HOB - HINTS AND TIPS.....	12
8. HOB - CARE AND CLEANING.....	13
9. OVEN - DAILY USE.....	13
10. OVEN - CLOCK FUNCTIONS.....	16
11. OVEN - HINTS AND TIPS.....	17
12. OVEN - CARE AND CLEANING.....	29
13. TROUBLESHOOTING.....	32
14. ENERGY EFFICIENCY.....	33
15. ENVIRONMENTAL CONCERNS.....	34

1. ⚠ SAFETY INFORMATION

Before the installation and use of the appliance, carefully read the supplied instructions. The manufacturer is not responsible for any injuries or damage that are the result of incorrect installation or usage. Always keep the instructions in a safe and accessible location for future reference.

1.1 Children and vulnerable people safety

- This appliance can be used by children aged from 8 years and above and persons with reduced physical, sensory or mental capabilities or lack of experience and knowledge if they have been given supervision or instruction concerning the use of the appliance in a safe way and understand the hazards involved. Children of less than 8 years of age and persons with very extensive and complex disabilities shall

be kept away from the appliance unless continuously supervised.

- Children should be supervised to ensure that they do not play with the appliance.
- Keep all packaging away from children and dispose of it appropriately.
- **WARNING:** The appliance and its accessible parts become hot during use. Keep children and pets away from the appliance when in use and when cooling down.
- Children shall not carry out cleaning and user maintenance of the appliance without supervision.

1.2 General Safety

- This appliance is for cooking purposes only.
- This appliance is designed for single household domestic use in an indoor environment.
- This appliance may be used in, offices, hotel guest rooms, bed & breakfast guest rooms, farm guest houses and other similar accommodation where such use does not exceed (average) domestic usage levels.
- Only a qualified person must install this appliance and replace the cable.
- This appliance is intended for use up to an altitude of 2000 m above sea level.
- This appliance is not intended to be used on ships, boats or vessels.
- Do not install the appliance behind a decorative door in order to avoid overheating.
- Do not install the appliance on a platform.
- Do not operate the appliance by means of an external timer or separate remote-control system.
- **WARNING:** Unattended cooking on a hob with fat or oil can be dangerous and may result in fire.
- Never use water to extinguish the cooking fire. Switch off the appliance and cover flames with e.g. a fire blanket or lid.

- **CAUTION:** The cooking process has to be supervised. A short term cooking process has to be supervised continuously.
- **WARNING:** Danger of fire: Do not store items on the cooking surfaces.
- Do not use a steam cleaner to clean the appliance.
- Do not use harsh abrasive cleaners or sharp metal scrapers to clean the glass door or the glass of hinged lids of the hob since they can scratch the surface, which may result in shattering of the glass.
- Metallic objects such as knives, forks, spoons and lids should not be placed on the hob surface since they can get hot.
- If the glass ceramic surface / glass surface is cracked, switch off the appliance and unplug it from the mains. In case the appliance is connected to the mains directly using junction box, remove the fuse to disconnect the appliance from power supply. In either case contact the Authorised Service Centre.
- **WARNING:** The appliance and its accessible parts become hot during use. Care should be taken to avoid touching heating elements.
- Always use oven gloves to remove or insert accessories or ovenware.
- Before maintenance, cut the power supply.
- **WARNING:** Ensure that the appliance is switched off before replacing the lamp to avoid the possibility of electric shock.
- If the mains power supply cable is damaged, it must be replaced by the manufacturer, its Authorised Service Centre or similarly qualified persons to avoid an electrical hazard.
- Use only the food sensor (core temperature sensor) recommended for this appliance.
- Be careful when you touch the storage drawer. It can get hot.

- To remove the shelf supports first pull the front of the shelf support and then the rear end away from the side walls. Install the shelf supports in the opposite sequence.
- **WARNING:** Use only hob guards designed by the manufacturer of the cooking appliance or indicated by the manufacturer of the appliance in the instructions for use as suitable or hob guards incorporated in the appliance. The use of inappropriate guards can cause accidents.

2. SAFETY INSTRUCTIONS

2.1 Installation

WARNING!

Only a qualified person must install this appliance.

- Remove all the packaging.
- Do not install or use a damaged appliance.
- Follow the installation instructions supplied with the appliance.
- Always take care when moving the appliance as it is heavy. Always use safety gloves and enclosed footwear.
- Do not pull the appliance by the handle.
- The kitchen cabinet and the recess must have suitable dimensions.
- Keep the minimum distance from other appliances and units.
- Install the appliance in a safe and suitable place that meets installation requirements.
- Parts of the appliance carry current. Close the appliance with furniture to prevent touching the dangerous parts.
- The sides of the appliance must stay next to appliances or units with the same height.
- Do not install the appliance adjacent to a door or under a window. This prevents hot cookware to fall from the appliance when the door or the window is opened.
- Make sure to install a stabilizing means in order to prevent tipping of the appliance. Refer to Installation chapter.

2.2 Electrical Connection

WARNING!

Risk of fire and electric shock.

- All electrical connections should be made by a qualified electrician.
- The appliance must be earthed.
- Make sure that the parameters on the rating plate are compatible with the electrical ratings of the mains power supply.
- Always use a correctly installed shockproof socket.
- Do not use multi-plug adapters and extension cables.
- Do not let mains cables touch or come near the appliance door or the niche below the appliance, especially when it operates or the door is hot.
- The shock protection of live and insulated parts must be fastened in such a way that it cannot be removed without tools.
- Connect the mains plug to the mains socket only at the end of the installation. Make sure that there is access to the mains plug after the installation.
- If the mains socket is loose, do not connect the mains plug.
- Do not pull the mains cable to disconnect the appliance. Always pull the mains plug.
- Use only correct isolation devices: line protecting cut-outs, fuses (screw type fuses removed from the holder), earth leakage trips and contactors.
- The electrical installation must have an isolation device which lets you disconnect

the appliance from the mains at all poles. The isolation device must have a contact opening width of minimum 3 mm.

- Fully close the appliance door before you connect the mains plug to the mains socket.

2.3 Use

WARNING!

Risk of injury and burns.
Risk of electrical shock.

- Do not change the specification of this appliance.
- Make sure that the ventilation openings are not blocked.
- Do not let the appliance stay unattended during operation.
- Deactivate the appliance after each use.
- Be careful when you open the appliance door while the appliance is in operation. Hot air can release.
- Do not operate the appliance with wet hands or when it has contact with water.
- Do not use the appliance as a work surface or as a storage surface.
- Do not use aluminum foil or other materials between the cooking surface and the cookware, unless otherwise specified by the manufacturer of this appliance.
- Use only accessories recommended for this appliance by the manufacturer.

WARNING!

Risk of fire and explosion.

- Fats and oil when heated can release flammable vapours. Keep flames or heated objects away from fats and oils when you cook with them.
- The vapours that very hot oil releases can cause spontaneous combustion.
- Used oil, that can contain food remnants, can cause fire at a lower temperature than oil used for the first time.
- Do not put flammable products or items that are wet with flammable products in, near or on the appliance.
- Do not let sparks or open flames to come in contact with the appliance when you open the door.

- Open the appliance door carefully. The use of ingredients with alcohol can cause a mixture of alcohol and air.

WARNING!

Risk of damage to the appliance.

- To prevent damage or discoloration to the enamel:
 - do not put ovenware or other objects in the appliance directly on the bottom.
 - do not put aluminium foil directly on the bottom of cavity.
 - do not put water directly into the hot appliance.
 - do not keep moist dishes and food in the appliance after you finish the cooking.
 - be careful when you remove or install the accessories.
- Discoloration of the enamel or stainless steel has no effect on the performance of the appliance.
- Use a deep pan for moist cakes. Fruit juices cause stains that can be permanent.
- Do not keep hot cookware on the control panel.
- Do not let cookware boil dry.
- Be careful not to let objects or cookware fall on the appliance. The surface can be damaged.
- Do not activate the cooking zones with empty cookware or without cookware.
- Cookware made of cast iron, aluminium or with a damaged bottom can cause scratches. Always lift these objects up when you have to move them on the cooking surface.

2.4 Care and Cleaning

WARNING!

Risk of injury, fire, or damage to the appliance.

- Before maintenance, deactivate the appliance. Disconnect the mains plug from the mains socket.
- Make sure the appliance is cold. There is the risk that the glass panels can break.

- Replace immediately the door glass panels when they are damaged. Contact the Authorised Service Centre.
- Be careful when you remove the door from the appliance. The door is heavy!
- Fat and food remaining in the appliance can cause fire.
- Clean regularly the appliance to prevent the deterioration of the surface material.
- Make sure the cavity and the door are wiped dry after each use. Steam produced during the operation of the appliance condensates on cavity walls and can cause corrosion. To decrease the condensation operate the appliance for 10 minutes before cooking.
- Clean the appliance with a moist soft cloth. Use only neutral detergents. Do not use abrasive products, abrasive cleaning pads, solvents or metal objects.
- If you use an oven spray, follow the safety instructions on the packaging.
- Do not clean the catalytic enamel (if applicable) with any kind of detergent.

2.5 Internal lighting

WARNING!

Risk of electric shock.

- Concerning the lamp(s) inside this product and spare part lamps sold separately: These lamps are intended to withstand extreme physical conditions in household

- appliances, such as temperature, vibration, humidity, or are intended to signal information about the operational status of the appliance. They are not intended to be used in other applications and are not suitable for household room illumination.
- This product contains a light source of energy efficiency class G.
 - Use only lamps with the same specifications.

2.6 Service

- To repair the appliance contact the Authorised Service Centre.
- Use original spare parts only.

2.7 Disposal

WARNING!

Risk of injury or suffocation.

- Contact your municipal authority for information on how to dispose of the appliance.
- Disconnect the appliance from the mains supply.
- Cut off the mains electrical cable close to the appliance and dispose of it.
- Remove the door catch to prevent children or pets from becoming trapped in the appliance.

3. INSTALLATION

WARNING!

Refer to Safety chapters.

3.1 Technical data

Dimensions

Height	850 - 936 mm
Width	596 mm
Depth	600 mm

3.2 Electrical installation

WARNING!

The manufacturer is not responsible if you do not follow the safety precautions from Safety chapters.

This appliance is supplied with a main plug and a main cable.

WARNING!

The power cable must not touch the part of the appliance shaded in the illustration.

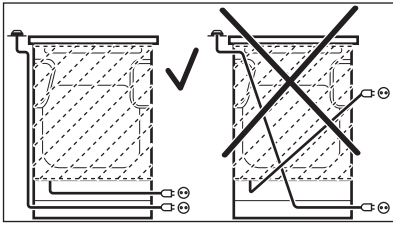

3.3 Anti-tilt protection

CAUTION!

Install the anti-tilt protection to prevent the appliance from falling under incorrect loads. The anti-tilt protection only works when the appliance is put in a correct area.

Your appliance has the symbols shown on the pictures (if applicable) to remind you about the installation of the anti-tilt protection.

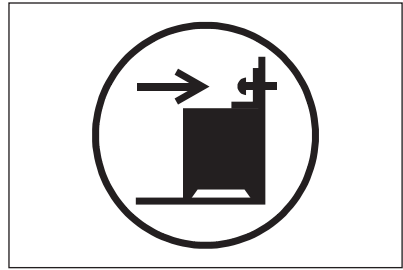

Make sure you install the anti-tilt protection at the correct height.

For more information about the installation of the appliance refer to a separate installation booklet

4. PRODUCT DESCRIPTION

4.1 General overview

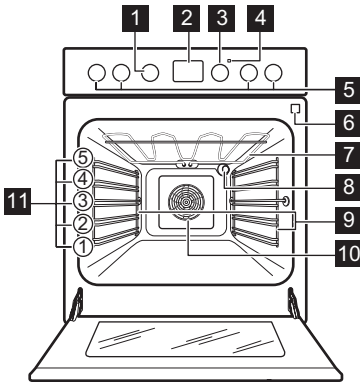

- 1 Knob for the oven functions
- 2 Display
- 3 Knob for the temperature
- 4 Temperature indicator / symbol
- 5 Knobs for the hob
- 6 Socket for the core temperature sensor
- 7 Heating element
- 8 Lamp
- 9 Shelf support, removable
- 10 Fan
- 11 Shelf positions

4.2 Hob overview

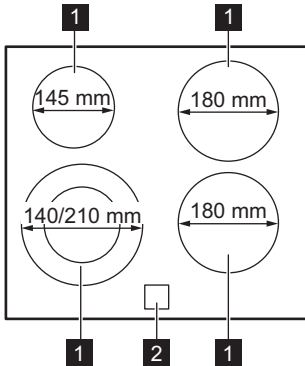

- 1 Cooking zone
- 2 Residual Heat Indicator

4.3 Accessories

- **Wire shelf**
For cookware, cake tins, roasts.
- **Baking tray**
For cakes and biscuits.
- **Grill- / Roasting pan**
To bake and roast or as pan to collect fat.

- **Core temperature sensor**
To measure how far the food is cooked.
- **Storage drawer**
The storage drawer is below the oven cavity.

5. BEFORE FIRST USE

WARNING!

Refer to Safety chapters.

5.1 Initial Cleaning

Remove all accessories and removable shelf supports from the oven.



Refer to "Care and cleaning" chapter.



Clean the oven and the accessories before the first use.

Put the accessories and the removable shelf supports back to their initial position.

5.2 Setting the time

You must set the time before you operate the oven.

The  flashes when you connect the appliance to the electrical supply, when there was a power cut or when the timer is not set.

Press the  or  to set the correct time. After approximately five seconds, the flashing stops and the display shows the time of day you set.

5.3 Changing the time





You cannot change the time of day if any of the functions operates.

Press  again and again until the indicator for the Time of Day function flashes. To set a new time, refer to "Setting the time".

5.4 Preheating

Preheat the empty oven before first use.

1. Set the function . Set the maximum temperature.
2. Let the oven operate for 1 hour.
3. Set the function . Set the maximum temperature.
4. Let the oven operate for 15 minutes.

5. Set the function . Set the maximum temperature.
6. Let the oven operate for 15 minutes.
7. Turn off the oven and let it cool down. Accessories can become hotter than usual. The oven can emit an odour and smoke. Make sure that the airflow in the room is sufficient.

5.5 Opening and closing the door with the mechanical door lock

The mechanical door lock is activated by default.

To open the door move the lock to the right.

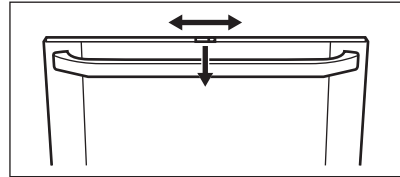

Close the door without pressing the lever.

5.6 Deactivating the mechanical door lock - in the main oven

1. Press the door trim B at each side. The seal releases.

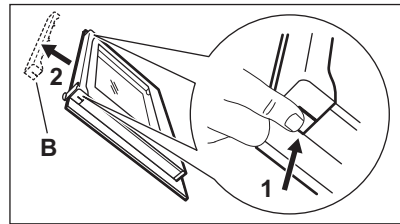

2. Pull the door trim up and remove it.
3. Remove the lever 1, move it to the right 2 and put it back in.

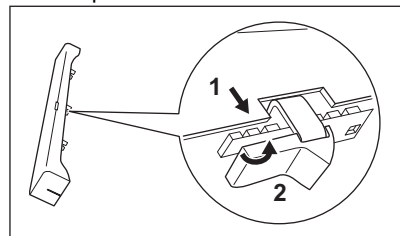

4. Hold the door trim B at each side and position it on the inner edge of the door. Put the door trim into the top edge of the door.

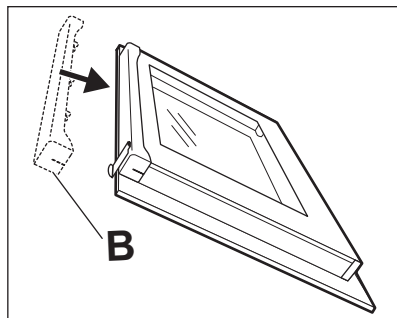

Activating the mechanical door lock

Do the above procedure again and move the lever back to the left.





Deactivating the appliance does not deactivate the mechanical door lock.

6. HOB - DAILY USE

WARNING!

Refer to Safety chapters.

6.1 Heat setting

Symbols	Function
0	Off position
	Double zone
	Keep warm
1 - 9	Heat settings



Use the residual heat to decrease energy consumption. Deactivate the cooking zone approximately 5 - 10 minutes before the cooking process is completed.

Turn the knob for the selected cooking zone to a necessary heat setting.

To complete the cooking process, turn the knob to the off position.

6.2 Activating and deactivating the outer rings

You can adjust the surface you cook to the dimension of the cookware.

To activate the outer ring: turn the knob clockwise through a light resistance to . Then turn the knob counterclockwise to the correct heat setting.

To deactivate the outer ring: turn the knob to the off position. The indicator goes out.

6.3 Residual heat indicator

WARNING!

As long as the indicator is visible, there is a risk of burns from residual heat.

The indicator appears when a cooking zone is hot, but it does not function if mains power is disconnected.

The indicator may also appear:

- for the neighbouring cooking zones even if you are not using them,
- when hot cookware is placed on cold cooking zone,
- when the hob is deactivated but the cooking zone is still hot.

The indicator disappears when the cooking zone has cooled down.

7. HOB - HINTS AND TIPS

WARNING!

Refer to Safety chapters.

7.1 Cookware

The cooking results depend on the cookware material

i

The bottom of the cookware must be as thick and flat as possible. Ensure pan bases are clean and dry before placing on the hob surface.

i

Do not use cookware on the ceramic hob with bases with pronounced edges or ridges, e.g. cast iron pans. These could scratch or scour the hob surface permanently.

i

Cookware made of enamelled steel and with aluminium or copper bottoms can cause a colour change on the glass-ceramic surface.

To save energy and ensure that the hob operates properly the cookware bottom must have a suitable minimum diameter.

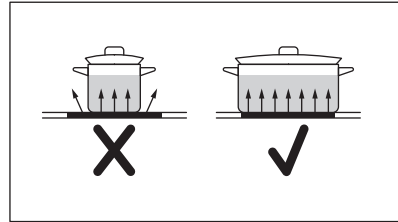

7.2 Minimum cookware diameter

Cooking zone	Cookware diameter (mm)	Power (W)
Left rear	125 - 145	1200
Right rear	150 - 180	1800
Right front	150 - 180	1800
Left front	140 - 210	1000/2200

7.3 Simplified cooking guide

i

The data in the table is for guidance only.

Heat setting	Use to:	Time (min)	Hints
 - 1	Keep cooked food warm.	as necessary	Put a lid on the cookware.
1 - 2	Hollandaise sauce; melt: butter, chocolate, gelatine.	5 - 25	Mix from time to time.
2	Solidify: fluffy omelettes, baked eggs.	10 - 40	Cook with a lid on.
2 - 3	Simmer rice and milk-based dishes, heat up ready-cooked meals.	25 - 50	Add at least twice as much liquid as rice, mix milk dishes halfway through the procedure.
3 - 4	Stew vegetables, fish, meat.	20 - 45	Add a few tablespoons of water. Check the water amount during the process.

Heat setting	Use to:	Time (min)	Hints
4 - 5	Steam potatoes and other vegetables.	20 - 60	Cover the bottom of the pot with 1-2 cm of water. Check the water level during the process. Keep the lid on the pot.
4 - 5	Cook larger quantities of food, stews and soups.	60 - 150	Up to 3 l of liquid plus ingredients.
6 - 7	Gentle fry: escalope, veal cordon bleu, cutlets, rissoles, sausages, liver, roux, eggs, pancakes, doughnuts.	as necessary	Turn over when needed.
7 - 8	Heavy fry, hash browns, loin steaks, steaks.	5 - 15	Turn over when needed.
9	Boil water, cook pasta, sear meat (goulash, pot roast), deep-fry chips.		

8. HOB - CARE AND CLEANING

WARNING!

Refer to Safety chapters.

8.1 General information

- Clean the hob after each use.
- Always use cookware with a clean base.
- Scratches or dark stains on the surface have no effect on how the hob operates.
- Use a special cleaning agent suitable for the surface of the hob.
- Always use a scraper recommended for hobs with a glass surface. Use the scraper only as an additional tool for cleaning the glass after the standard cleaning procedure.

WARNING!

Do not use knives or any other sharp, metal tools to clean the glass surface.

8.2 Cleaning the hob

- **Remove immediately:** melted plastic, plastic foil, salt, sugar and food with sugar, otherwise, the dirt can cause damage to the hob. Take care to avoid burns. Use a special hob scraper on the glass surface at an acute angle and move the blade on the surface.
- **Remove when the hob is sufficiently cool:** limescale rings, water rings, fat stains, shiny metallic discoloration. Clean the hob with a moist cloth and a non-abrasive detergent. After cleaning, wipe the hob dry with a soft cloth.
- **Remove shiny metallic discoloration:** use a solution of water with vinegar and clean the glass surface with a cloth.

9. OVEN - DAILY USE









WARNING!

Refer to Safety chapters.

9.1 Oven functions

WARNING!

Do not pour any liquids into the cavity embossment before and during the cooking process. There is a risk of damage.

Symbol	Oven function	Application
	Off position	The oven is off.
	Hot Air	To bake on up to two shelf positions at the same time and to dry food. Set the temperature 20 - 40 °C lower than for Conventional.
	Pie / Pizza	To bake food on one shelf position for a more intensive browning and a crispy bottom.
	Conventional	To bake and roast food on one shelf position.
	Drying	To dry sliced fruit, vegetables and mushrooms.
	Max Grill	To grill flat food in large quantities and to toast bread.
	Turbo Grilling	To roast larger meat joints and poultry with bones on one shelf position. Also to make gratins and to brown.
	Moist Fan Baking	This function was used to comply with the Energy Efficiency Class and Ecodesign Regulations (according to EU 65/2014 and EU 66/2014). Tests according to: IEC/EN 60350-1. The oven door should be closed during cooking so that the function is not interrupted and to ensure that the oven operates with the highest energy efficiency possible. When you use this function, the temperature in the cavity may differ from the set temperature. The heating power may be reduced. For general energy saving recommendations refer to "Energy Efficiency" chapter, Energy Saving. This function is designed to save energy during cooking. For the cooking instructions refer to "Hints and tips" chapter, Moist Fan Baking. When you use this function the lamp automatically turns off.



You can defrost food by choosing Moist Fan Baking function without setting the temperature.

9.2 Activating and deactivating the oven



It depends on the model if your appliance has knob symbols, indicators or lamps:

- The indicator comes on when the oven heats up.
- The lamp comes on when the oven operates.
- The symbol shows whether the knob controls one of the cooking zones, the oven functions or the temperature.

1. Turn the knob for the oven functions to select an oven function.
2. Turn the knob for the temperature to select a temperature.
3. To deactivate the oven turn the knobs for the oven functions and temperature to the off position.

9.3 Cooling fan

When the oven operates, the cooling fan turns on automatically to keep the surfaces of the oven cool. If you turn off the oven, the cooling fan continues to operate until the oven cools down.

9.4 Using the core temperature sensor

The core temperature sensor measures the core temperature of the meat.

There are two temperatures to be set:



- The oven temperature. Refer to the table for roasting.
- The core temperature. Refer to the table for the core temperature sensor.

⚠ CAUTION!

Only use the core temperature sensor supplied with the appliance, or genuine replacement parts.

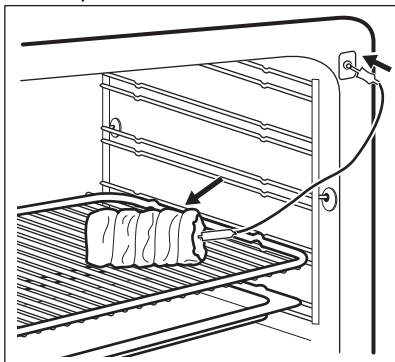
1. Put the point of the core temperature sensor into the centre of the meat.
2. Put the plug of the core temperature sensor into the socket on the front of the appliance. The indicator for the core temperature sensor  flashes.



3. Press the button  or  to set the core temperature. You can set the temperature from 30 °C to 99 °C. Refer to values in the table.
4. Set the oven function and the oven temperature.
5. Press a button to stop the signal. An acoustic signal sounds for two minutes, when the meat is at the set core temperature.
6. Deactivate the appliance.
7. Remove the plug of the core temperature sensor from the socket. Remove the meat from the appliance.

If the meat is not cooked to your satisfaction, do the above steps again and set a higher core temperature.

You can change the temperature at any time during the cooking. Press  to change the set core temperature.

⚠ WARNING!

Be careful when you remove the tip and plug of the core temperature sensor. The core temperature sensor is hot. There is a risk of burns.

9.5 Inserting the oven accessories

Deep pan:

Push the deep pan between the guide bars of the shelf support.

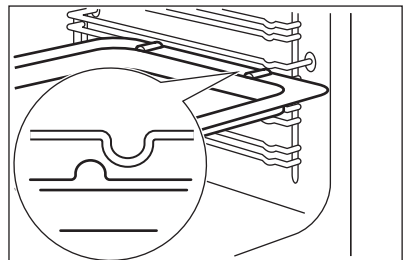

Wire shelf:

Push the shelf between the guide bars of the shelf support.

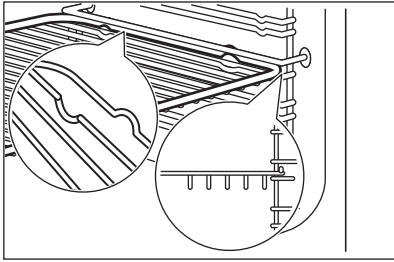

- All accessories have small indentations at the top of the right and left side to increase safety. The indentations are also anti-tip devices.
- The high rim around the shelf is a device which prevents cookware from slipping.

10. OVEN - CLOCK FUNCTIONS

10.1 Display

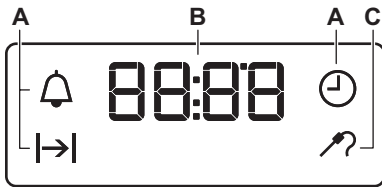

- A. Clock functions
- B. Timer
- C. Food sensor indicator

10.2 Buttons

Button	Function	Description
—	MINUS	To set the time.
	CLOCK	To set a clock function.
+	PLUS	To set the time.

10.3 Clock functions

Clock function		Application
	TIME OF DAY	To set, change or check the time of day.
	DURATION	To set how long the oven works.
	MINUTE MINDER	To set a countdown. This function has no effect on the operation of the oven. You can set this function at any time, also when the oven is off.

10.4 Setting the DURATION

1. Set an oven function and temperature.
2. Press again and again until starts to flash.

3. Press **+** or **-** to set the DURATION time.

The display shows **|→|**.

4. When the time ends, **|→|** flashes and an acoustic signal sounds. The appliance deactivates automatically.
5. Press any button to stop the acoustic signal.
6. Turn the knob for the oven functions and the knob for the temperature to the off position.

10.5 Setting the MINUTE MINDER

1. Press **🔔** again and again until **🔔** starts to flash.
2. Press **+** or **-** to set the necessary time.

The Minute Minder starts automatically after 5 seconds.

3. When the set time ends, an acoustic signal sounds. Press any button to stop the acoustic signal.
4. Turn the knob for the oven functions and the knob for the temperature to the off position.

10.6 Cancelling the clock functions

1. Press the **🔔** again and again until the necessary function indicator starts to flash.
2. Press and hold **-**.
The clock function goes out after some seconds.

11. OVEN - HINTS AND TIPS

WARNING!

Refer to Safety chapters.

i

The temperature and baking times in the tables are guidelines only. They depend on the recipes and the quality and quantity of the ingredients used.

You can extend the baking time by 10 – 15 minutes if you bake cakes on more than one shelf position.

Cakes and pastries at different heights do not always brown equally. There is no need to change the temperature setting if an unequal browning occurs. The differences equalize during baking.

Trays in the oven can distort during baking. When the trays are cold again, the distortions disappear.

11.1 Baking

For the first baking, use the lower temperature.

11.2 Tips on baking

Baking results	Possible cause	Remedy
The bottom of the cake is not baked sufficiently.	The shelf position is incorrect.	Put the cake on a lower shelf.
The cake sinks and becomes soggy or streaky.	The oven temperature is too high.	Next time set slightly lower oven temperature.
	The oven temperature is too high and the baking time is too short.	Next time set a longer baking time and lower oven temperature.
The cake is too dry.	The oven temperature is too low.	Next time set higher oven temperature.
	The baking time is too long.	Next time set shorter baking time.

Baking results	Possible cause	Remedy
The cake bakes unevenly.	The oven temperature is too high and the baking time is too short.	Next time set a longer baking time and lower oven temperature.
	The cake batter is not evenly distributed.	Next time spread the cake batter evenly on the baking tray.
The cake is not ready in the baking time specified in a recipe.	The oven temperature is too low.	Next time set a slightly higher oven temperature.

11.3 Hot Air Baking

Food	Temperature (°C)	Time (min)	Shelf position
Bread rolls	175 - 185	15 - 20	2 + 4
Wholemeal rolls	165 - 180	20 - 30	2 + 4
Filled sandwiches	170 - 180	15 - 20	2 + 4
Pan loaf	170 - 190	30 - 40	1 + 4
Pretzels	160 - 170	15 - 20	2 + 4
White loaf / Round loaf	170 - 180	35 - 45	2 + 4
Wholemeal loaf	160 - 170	35 - 45	2 + 4
Rye bread, mix	250	-	2 + 4
- baking	160 - 170	60 - 70	2 + 4
Baguettes	180 - 200	20 - 30	2 + 4
Pancakes	150 - 160	50 - 60	3
Fruit cakes	140 - 150	70 - 80	3
Muffins	160 - 170	15 - 25	2 + 4
Jam roll	190 - 210	6 - 15	3
Buns	185 - 195	8 - 15	2 + 4
Long loaf	170 - 180	25 - 35	2 + 4
Gingerbread	160 - 170	8 - 15	2 + 4
Dish cake	150 - 160	30 - 40	2 + 4
Sponge cakes / Madeira cakes	150 - 160	50 - 60	2
Meringues	90 - 110	90 - 120	2 + 4
Meringue bases	90 - 110	90 - 120	2 + 4
Biscuits	150 - 160	10 - 20	2 + 4
Choux pastry	155 - 165	30 - 40	2 + 4

Food	Temperature (°C)	Time (min)	Shelf position
Fruit tarts, short crust pastry	150 - 160	pre-baking, bases 10 - 15	2 + 4
Fruit tarts, short crust pastry	150 - 160	finishing 35 - 45	2 + 4
Fruit tarts, crumble pastry	170 - 180	30 - 40	2 + 4

11.4 Hot Air Cooking

Food	Temperature (°C)	Time (min)	Shelf position
Fish, boiling	150 - 160	_ 1)	2 + 4
Fish, frying	165 - 175	_ 1)	2 + 4
Meatloaf	165 - 175	60 - 70	2 + 4
Danish meatballs	165 - 175	35 - 45	2 + 4
Liver pâté	165 - 175	65 - 75	2 + 4
Potato gratin	170 - 190	55 - 65	2 + 4
Lasagne, home made	170 - 190	60 - 70	2 + 4
Lasagne, frozen	170 - 190	30 - 45 2)	2 + 4
Pasta gratin	165 - 175	40 - 50	2 + 4
Chips, frozen	180 - 200	30 - 45 2)	2 + 4
Tarts, home made - pre-baking, roll	165 - 175	15 - 20	2 + 4
Tarts, home made - finishing	165 - 175	30 - 40	2 + 4
Tarts, frozen	170 - 190	25 - 35 2)	2 + 4

1) When frying or boiling fish, the cooking time depends on the thickness of the fish. The fish is finished when the flesh is white. Test by sticking a fork into the fish. If the flesh comes easily away from the bone, the fish is cooked.

2) With cooking on two levels (double portion) the time is around 1/3 longer than that stated on the packaging. If the time given is 30 mins, then the preparation time will be around 30 + 10 = 40 min.

11.5 Conventional Baking

Food	Temperature (°C)	Time (min)	Shelf position
Bread rolls	200 - 225	8 - 12	3 - 4
Wholemeal rolls	190 - 200	20 - 25	3 - 4
Filled sandwiches	200 - 225	10 - 12	3 - 4
Ciabatta rolls	210 - 230	10 - 20	3 - 4

Food	Temperature (°C)	Time (min)	Shelf position
Focaccia	220 - 230	15 - 20	3 - 4
Pita bread	250	5 - 15	3 - 4
Pretzels	180 - 200	12 - 15	3 - 4
White loaf	190 - 210	25 - 40	1 - 2
Ciabatta	210 - 220	15 - 25	1 - 2
Wholemeal loaf	180 - 200	35 - 45	1 - 2
Rye bread baking	180 - 200	55 - 65	1
- baking	190	55 - 65	1
Baguettes	220 - 230	15 - 30	3 - 4
Pancake	170 - 180	50 - 60	2 - 3
Dish cake	170 - 180	35 - 45	3 - 4
Sponge cakes / Madeira cakes	170 - 180	40 - 50	1 - 2
Sandwich cake, roll	200 - 225	8 - 12	3 - 4
Meringues	90 - 110	90 - 120	3 - 4
Meringue bases	90 - 110	90 - 120	3 - 4
Biscuits	160 - 180	6 - 15	3 - 4
Choux pastry	170 - 190	30 - 45	3 - 4
Swiss rolls	190 - 210	10 - 12	3 - 4
Fruit tarts, short crust pastry	175 - 200	pre-baking, roll 10 - 15	3 - 4
Fruit tarts, short crust pastry	170 - 180	finishing 35 - 45	3 - 4
Fruit tarts, crumble pastry	190 - 200	25 - 35	3 - 4
Marzipan ring cake	210 - 230	10 - 12	2

11.6 Conventional Cooking

Food	Temperature (°C)	Time (min)	Shelf position
Fish, boiling	160 - 170	_1)	3
Fish, frying	180 - 200	_1)	3
Meatloaf	175 - 200	45 - 60	3
Danish meatballs	175 - 200	30 - 45	3
Liver pâté	180 - 200	50 - 60	3

Food	Temperature (°C)	Time (min)	Shelf position
Gratin	180 - 200	50 - 60	3
Potato gratin	190 - 210	55 - 65	3
Lasagne, home made	190 - 210	50 - 60	3
Lasagne, frozen	175 - 200	30 - 45 ²⁾	3
Pasta gratin	180 - 200	30 - 40	3
Chips, frozen	225 - 250	20 - 30 ²⁾	3
Tarts, home made - pre-baking, roll	190 - 210	15 - 25	3
Tarts, home made - finishing	190 - 210	20 - 30	3
Tarts, frozen	200 - 225	20 - 30 ²⁾	3

1) When frying or boiling fish, the cooking time depends on the thickness of the fish. The fish is finished when the flesh is white. Test by sticking a fork into the fish. If the flesh comes easily away from the bone, the fish is cooked.

2) With cooking on two levels (double portion) the time is around 1/3 longer than that stated on the packaging. If the time given is 30 min, then the preparation time will be around $30 + 10 = 40$ min.

11.7 Pizza Table

Food	Temperature (°C)	Time (min)	Shelf position
Ciabatta rolls	200 - 220	10 - 20	2
Foccacia	220 - 230	10 - 20	2
Ciabatta	190 - 200	15 - 25	2
Fruit tarts, short crust pastry	170 - 180	35 - 45	2
Fruit tarts, crumble pastry	175 - 200	25 - 35	2
Pizza, home made (thick - with a lot of topping)	180 - 200	25 - 35	1
Pizza, home made (thin crust)	200 - 230 ¹⁾	15 - 20	1
Pizza, frozen	190 - 200	15 - 20	3
Tarts, home made pre-baking, roll	175 - 200	35 - 45	3
Tarts, home made finishing	175 - 200	35 - 45	3
Tarts, frozen	190 - 210	15 - 25	3

1) Preheat the oven.

11.8 Moist Fan Baking

Bread and pizza

Food	Temperature (°C)	Time (min)	Shelf position
Buns	180	25 - 35	3

Food	Temperature (°C)	Time (min)	Shelf position
Frozen pizza 350 g	190	25 - 35	3

Cakes in baking tray

Food	Temperature (°C)	Time (min)	Shelf position
Swiss roll	180	20 - 30	3
Brownie	180	30 - 40	3

Cakes in tin

Food	Temperature (°C)	Time (min)	Shelf position
Soufflè	200	30 - 40	3
Sponge flan base	180	20 - 30	3
Victoria sandwich	150	25 - 35	3

Fish

Food	Temperature (°C)	Time (min)	Shelf position
Fish in pouches 300 g	180	25 - 35	3
Whole fish 200 g	180	25 - 35	3
Fish fillet 300 g	180	25 - 35	3

Meat

Food	Temperature (°C)	Time (min)	Shelf position
Meat in pouch 250 g	200	25 - 35	3
Meat skewers 500 g	200	30 - 40	3

Small baked items

Food	Temperature (°C)	Time (min)	Shelf position
Cookies	180	25 - 35	3
Macaroons	160	25 - 35	3
Muffins	180	25 - 35	3
Savoury cracker	170	20 - 30	3
Short crust pastry biscuits	150	25 - 35	3
Tartelettes	170	15 - 25	3

Vegetarian

Food	Temperature (°C)	Time (min)	Shelf position
Mixed vegetables in pouch 400 g	180	25 - 35	3
Omelette	200	20 - 30	3
Vegetables on tray 700 g	180	25 - 35	3

11.9 Tips on Roasting

Use heat-resistant ovenware.

Roast lean meat covered (you can use aluminium foil).

Roast large meat joints directly in the tray.

Put some water in the tray to prevent dripping fat from burning.

Turn the roast after 1/2 - 2/3 of the cooking time.

Roast meat and fish in large pieces (1 kg or more).

If level one is suggested put the food directly on the baking tray

Baste meat joints with their own juice several times during roasting.

11.10 Hot Air Roasting

Beef

Food	Temperature (°C)	Time (min / kg)	Shelf position
Roast beef ¹⁾	125	80 - 120	2 - 3
Rump steak - browning	200	total 10	2 - 3
Rump steak - roasting	150	50 - 60	2 - 3
Roast beef	160	90 - 120	1 - 2

¹⁾ Other. Can be browned off after roasting under the grill or with top / bottom heat at 250°C. If you are using a meat probe, remove it before grilling.

Veal

Food	Temperature (°C)	Time (min / kg)	Shelf position
Fillet of beef ¹⁾	160	60 - 70	2 - 3

¹⁾ Other. Can be browned off after roasting under the grill or with top / bottom heat at 250°C. If you are using a meat probe, remove it before grilling.

Lamb

Food	Temperature (°C)	Time (min / kg)	Shelf position
Leg / shoulder / saddle	160	80 - 100	2

Pork

Food	Temperature (°C)	Time (min / kg)	Shelf position
Roast pork ¹⁾	175	60 - 70	2 - 3
Pork loin ¹⁾	175	60	2 - 3
Neck fillets	160	90 - 120	2 - 3

Food	Temperature (°C)	Time (min / kg)	Shelf position
Ham	150	60 - 100	1 - 2

1) Other. Can be browned off after roasting under the grill or with top / bottom heat at 250°C. If you are using a meat probe, remove it before grilling.

Poultry

Food	Temperature (°C)	Time (min / kg)	Shelf position
Chicken, parted	180	55 - 65	2 - 3
Duck ¹⁾	150	55 - 65	2 - 3
Duck slow roasting ¹⁾	130	total around 5 hours	2 - 3
Roast turkey, stuffed	150	50 - 60	1 - 2
Turkey breast	175	70 - 80	2 - 3

1) Other. Can be browned off after roasting under the grill or with top / bottom heat at 250°C. If you are using a meat probe, remove it before grilling.

11.11 Conventional Roasting

Beef

Food	Temperature (°C)	Time (min / kg)	Shelf position
Roast beef ¹⁾	125	80 - 120	2 - 3
Rump steak - browning	225	total 10	2 - 3
Rump steak - roasting	160	50 - 60	2 - 3
Roast beef	180	90 - 120	1 - 3

1) Other. Can be browned off after roasting under the grill or with top / bottom heat at 250°C. If you are using a meat probe, remove it before grilling.

Veal

Food	Temperature (°C)	Time (min / kg)	Shelf position
Fillet of beef ¹⁾	180	60 - 70	2

1) Other. Can be browned off after roasting under the grill or with top / bottom heat at 250°C. If you are using a meat probe, remove it before grilling.

Lamb

Food	Temperature (°C)	Time (min / kg)	Shelf position
Leg / shoulder / rib	180	80 - 100	2

Pork

Food	Temperature (°C)	Time (min / kg)	Shelf position
Roast pork ¹⁾	200	60 - 70	3
Pork loin ¹⁾	200	60	3
Neck fillets	180	90 - 120	3
Ham	160	60 - 100	2

¹⁾ Other. Can be browned off after roasting under the grill or with top / bottom heat at 250°C. If you are using a meat probe, remove it before grilling.

Poultry

Food	Temperature (°C)	Time (min / kg)	Shelf position
Chicken, parted	200	55 - 65	2
Duck ¹⁾	160	55 - 65	2
Duck slow roasting ¹⁾	130	total around 5 hours	2
Roast turkey, stuffed	160	50 - 60	2
Turkey breast	200	70 - 80	2
Whole chicken	220	60 - 90	2

¹⁾ Other. Can be browned off after roasting under the grill or with top / bottom heat at 250°C. If you are using a meat probe, remove it before grilling.

11.12 Roasting with Turbo Grilling

Beef

Food	Quantity	Temperature (°C)	Time (min)	Shelf position
Roast beef or fillet: rare	per cm. of thickness	190 - 200 ¹⁾	5 - 6	1
Roast beef or fillet: medium	per cm. of thickness	180 - 190	6 - 8	1
Roast beef or fillet: well done	per cm. of thickness	170 - 180	8 - 10	1

¹⁾ Preheat the oven.

Pork

Food	Quantity	Temperature (°C)	Time (min)	Shelf position
Shoulder, neck, ham joint	1 - 1.5 kg	160 - 180	90 - 120	1
Chop, spare rib	1 - 1.5 kg	170 - 180	60 - 90	1
Meat loaf	750 g - 1 kg	160 - 170	50 - 60	1
Pork knuckle (pre-cooked)	750 g - 1 kg	150 - 170	90 - 120	1

Veal

Food	Quantity	Temperature (°C)	Time (min)	Shelf position
Roast veal	1 kg	160 - 180	90 - 120	1
Knuckle of veal	1.5 - 2 kg	160 - 180	120 - 150	1

Lamb

Food	Quantity	Temperature (°C)	Time (min)	Shelf position
Leg of lamb, roast lamb	1 - 1.5 kg	150 - 170	100 - 120	1
Saddle of lamb	1 - 1.5 kg	160 - 180	40 - 60	1

Poultry

Food	Quantity	Temperature (°C)	Time (min)	Shelf position
Poultry portions	200 - 250 g each	200 - 220	30 - 50	1
Duck	1.5 - 2 kg	180 - 200	80 - 100	1
Goose	3.5 - 5 kg	160 - 180	120 - 180	1
Turkey	2.5 - 3.5 kg	160 - 180	120 - 180	1
Turkey	4 - 6 kg	140 - 160	150 - 240	1
Whole chicken	1 - 1.5 kg	180 - 200	60 - 90	2

11.13 Core temperature sensor table

Beef

Food	Food core temperature (°C)	Shelf position
Roast beef	55 - 65	2 - 3
Rump steak - browning	55 - 65	2 - 3
Rump steak - roasting	55 - 65	2 - 3
Roast beef	75 - 80	1 - 2

Veal

Food	Food core temperature (°C)	Shelf position
Fillet of beef	65	2 - 3

Lamb

Food	Food core temperature (°C)	Shelf position
Leg / shoulder / saddle	90	2

Pork

Food	Food core temperature (°C)	Shelf position
Roast pork	80	2 - 3
Neck fillets	75 - 80	2 - 3
Ham	70 - 75	1 - 2

Poultry

Food	Food core temperature (°C)	Shelf position
Turkey breast	75 - 80	2 - 3

11.14 Grilling in general

WARNING!

Always grill with the oven door closed.

- **Always grill with the maximum temperature setting.**
- Set the shelf into the shelf position as recommended in the grilling table.
- If the first shelf position is recommended put the food directly on the baking tray.
- Always place the deep pan to collect fat on the first shelf position.

- Grill only flat pieces of meat or fish.

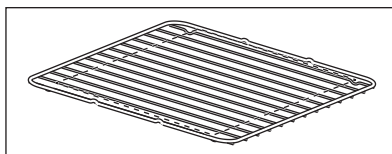

The grilling area is set in centre of the shelf.

11.15 Fast Grilling

Food	Temperature (°C)	Time (min)		Shelf position
		1st side	2nd side	
Burgers	max 1)	9 - 15	8 - 13	4
Pork fillet	max	10 - 12	6 - 10	4
Sausages	max	10 - 12	6 - 8	4
Fillet steaks, veal steaks	max	7 - 10	6 - 8	4
Toast	max 1)	1 - 4	1 - 4	4 - 5
Toast with topping	max	6 - 8	-	4

1) Pre-heat the oven

11.16 Drying

Cover the oven shelves with baking parchment.

For best results: deactivate the appliance after half the time required. Open the

appliance door and let the appliance cool down. After that finish the drying process.

Vegetables

Food	Temperature (°C)	Time (h)	Shelf position	
			1 position	2 positions
Beans	60 - 70	6 - 8	3	2 / 4
Peppers	60 - 70	5 - 6	3	2 / 4
Vegetables for sour	60 - 70	5 - 6	3	2 / 4
Mushrooms	50 - 60	6 - 8	3	2 / 4
Herbs	40 - 50	2 - 3	3	2 / 4

Fruit

Food	Temperature (°C)	Time (h)	Shelf position	
			1 position	2 positions
Plums	60 - 70	8 - 10	3	2 / 4
Apricots	60 - 70	8 - 10	3	2 / 4
Apple slices	60 - 70	6 - 8	3	2 / 4
Pears	60 - 70	6 - 9	3	2 / 4

11.17 Information for test institutes

Food	Function	Temperature (°C)	Time (min)	Accessories	Shelf position
Small cakes (20 small cakes per tray)	Conventional	170	20 - 30	Tray	4
Small cakes (20 small cakes per tray) ¹⁾	Hot Air	150	20 - 30	Tray	2
Small cakes (20 small cakes per tray) ¹⁾	Hot Air	150	25 - 35	Tray / Dripping Pan	1 + 4
Apple pie, 2 tins (ø 20 cm) on the grid, diagonally shifted	Conventional	180	70 - 90	Grid	1
Apple pie, 2 tins (ø 20 cm) on the grid, diagonally shifted	Hot Air	160	70 - 90	Grid	2
Apple pie, 2 tins (ø 20 cm) on the grid, diagonally shifted	Pie / Pizza	160	60 - 80	Grid	2
Fatless sponge cake, 1 tin (ø 26 cm) on the grid	Conventional	170	30 - 40	Grid	3
Fatless sponge cake, 1 tin (ø 26 cm) on the grid	Hot Air	150	35 - 45	Grid	2

Food	Function	Temperature (°C)	Time (min)	Accessories	Shelf position
Fatless sponge cake, 1 tin (ø 26 cm) on the grid ¹⁾	Hot Air	160	25 - 35	Grid	1 + 4
Shortbread/Pastry strip	Hot Air	140	20 - 35	Tray	3
Shortbread/Pastry strip	Hot Air	140	20 - 30	Tray	1 + 4
Shortbread/Pastry strip	Conventional	160	20 - 35	Tray	3
Toast ¹⁾	(Max) Grill	Max	1 - 5	Grid	4
Beef burger	Grill	Max	15 - 20 first side. 10 - 15 second side.	Grid / Dripping pan	4 + 1

1) Preheat the oven for 10 minutes.

12. OVEN - CARE AND CLEANING

WARNING!

Refer to Safety chapters.

12.1 Notes on cleaning



Cleaning Agents

Clean the front of the appliance only with a microfibre cloth with warm water and a mild detergent.

Use a cleaning solution to clean metal surfaces.

Clean stains with a mild detergent. Do not apply it on the catalytic surfaces.



Everyday Use

Clean the cavity after each use. Fat accumulation or other residue may cause fire.

Do not store the food in the appliance for longer than 20 minutes. Dry the cavity only with a microfibre cloth after each use.



Accessories

Clean all accessories after each use and let them dry. Use only a microfibre cloth with warm water and a mild detergent. Do not clean the accessories in a dishwasher.

Do not clean the non-stick accessories using abrasive cleaner or sharp-edged objects.

12.2 Stainless steel or aluminium ovens

Clean the oven door with a damp cloth or sponge only. Dry it with a soft cloth.

Do not use steel wool, acids or abrasive materials as they can damage the oven surface. Clean the oven control panel with the same precautions.

12.3 Catalytic cleaning

⚠ CAUTION!

Do not clean the catalytic surface with oven sprays, soap or other cleaning agents. It will damage the catalytic surface.

⚠ CAUTION!

Always turn the oven light on while using the catalytic cleaning (if applicable).

⚠ WARNING!

Keep children away when you clean the oven at a high temperature. The oven surface becomes very hot and there is a risk of burns.



Spots or discolouration of the catalytic surface have no effect on catalytic properties.



Before activating the catalytic cleaning remove all the accessories from the oven.

The walls with catalytic coating are self-cleaning. They absorb fat which collects on the walls while the appliance operates.

To support the self-cleaning procedure, heat the empty oven on a regular basis.

1. Clean the oven floor with warm water and washing-up liquid, then dry it.
2. Set the  function.
3. Set the oven temperature to 250 °C and let the oven operate for 1 hour.
4. When the appliance is cool, clean it with a soft and moist sponge.

12.4 Removing the shelf supports

To clean the oven, remove the shelf supports.

1. Pull the front of the shelf support away from the side wall.

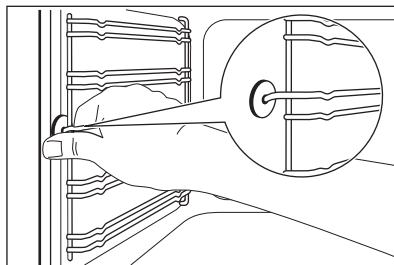

2. Pull the rear end of the shelf support away from the side wall and remove it.

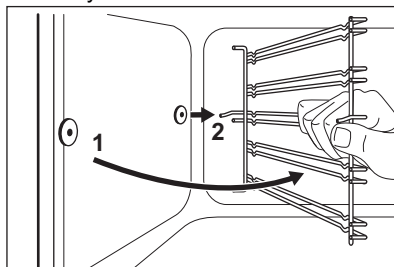

Install the shelf supports in the opposite sequence.

⚠ CAUTION!

Make sure that the longer fixing wire is in the front. The ends of the two wires must point to the rear. Incorrect installation can cause damage to the enamel.

12.5 Removing the oven door

To make the cleaning easier, remove the door.

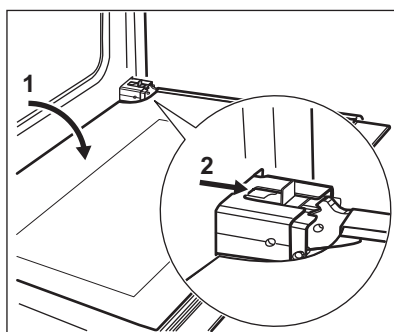

1. Open the door fully.
2. Move the slider until you hear a click.
3. Close the door until the slider locks.

4. Remove the door.

To remove the door, pull the door outwards first from one side, and then the other.

When the cleaning procedure is completed, insert the oven door in the opposite sequence. Make sure that you hear a click when you insert the door. Use force if necessary.

12.6 Removing and cleaning the door glasses



The door glass in your product can be different in type and shape from the examples you see in the images. The number of glasses can also be different.

1. Hold the door trim B on the top edge of the door at the two sides and push inwards to release the clip seal.

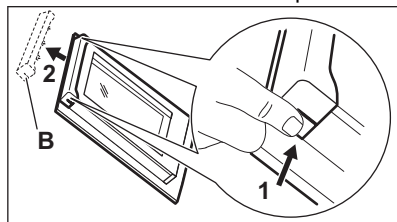

2. Pull the door trim to the front to remove it.
3. Hold the door glass panels on their top edge one by one and pull them upwards from the guide.

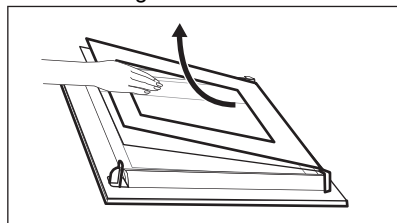

4. Clean the door glass panels.
To install panels, do the same steps in reverse.

12.7 Replacing the lamp

WARNING!

Risk of electric shock.
The lamp can be hot.

1. Turn off the oven. Wait until the oven is cold.
2. Disconnect the oven from the mains.
3. Put a cloth on the bottom of the cavity.

The back lamp



The lamp glass cover is at the back of the cavity.

1. Turn the lamp glass cover counterclockwise to remove it.
2. Clean the glass cover.
3. Replace the oven lamp with a suitable 300 °C heat-resistant oven lamp.
Use the same oven lamp type.
4. Install the glass cover.

12.8 The drawer

WARNING!

Do not put food inside the drawer.

WARNING!

Do not keep flammable items such as cleaning materials, plastic bags, oven gloves, paper, cleaning products, aerosols, plastic items) in the drawer. When you use the oven, the drawer can become hot. There is a risk of fire.

The drawer below the oven can be removed for cleaning.

Removing the drawer:

1. Pull the drawer out until it stops.
2. Lift the drawer slightly, so that can be lifted upwards at an angle of the drawer guides.

To install the drawer, follow the procedure in reverse.

13. TROUBLESHOOTING

WARNING!

Refer to Safety chapters.

13.1 What to do if...

Problem	Possible cause	Remedy
You cannot activate the appliance.	The appliance is not connected to an electrical supply or it is connected incorrectly.	Check if the appliance is correctly connected to the electrical supply.
You cannot activate the appliance.	The fuse is blown.	Make sure that the fuse is the cause of the malfunction. If the fuse is blown again and again, contact a qualified electrician.
Residual heat indicator does not come on.	The zone is not hot because it operated only for a short time.	If the zone operated sufficiently long to be hot, speak to an Authorised Service Centre.
You cannot activate the outer ring.		Activate the inner ring first.
The oven does not heat up.	The oven is deactivated.	Activate the oven.
The oven does not heat up.	The clock is not set.	Set the clock.
The oven does not heat up.	The necessary settings are not set.	Make sure that the settings are correct.
The lamp does not operate.	The lamp is defective.	Replace the lamp.
The display shows "12.00".	There was a power cut.	Reset the clock.
The display shows F11.	The plug of the core temperature sensor is not correctly installed into the socket.	Put the plug of the core temperature sensor as far as possible into the socket.
Steam and condensation settle on the food and in the cavity of the oven.	You left the dish in the oven for too long.	Do not leave the dishes in the oven for longer than 15 - 20 minutes after the cooking process ends.

13.2 Service data

If you cannot find a solution to the problem yourself, contact your dealer or an Authorised Service Centre.

The necessary data for the service centre is on the rating plate. The rating plate is on the front frame of the appliance cavity. Do not remove the rating plate from the appliance cavity.

We recommend that you write the data here:

Model (MOD.)
Product number (PNC)
Serial number (S.N.)

14. ENERGY EFFICIENCY

14.1 Product Information according to EU Ecodesign Regulations for hob

Model identification	LKR64440SW	
Type of hob	Hob inside Freestanding Cooker	
Number of cooking zones	4	
Heating technology	Radiant Heater	
Diameter of circular cooking zones (Ø)	Left front	21.0 cm
	Left rear	14.5 cm
	Right front	18.0 cm
	Right rear	18.0 cm
Energy consumption per cooking zone (EC electric cooking)	Left front	169.2 Wh/kg
	Left rear	188.3 Wh/kg
	Right front	195.5 Wh/kg
	Right rear	195.5 Wh/kg
Energy consumption of the hob (EC electric hob)	187.1 Wh/kg	

IEC/EN 60350-2 - Household electric cooking appliances - Part 2: Hobs - Methods for measuring performance.

14.2 Hob - Energy saving

You can save energy during everyday cooking if you follow the hints below.

- When you heat up water, use only the amount you need.
- If it is possible, always put the lids on the cookware.
- Before you activate the cooking zone put the cookware on it.
- The cookware bottom should have the same diameter as the cooking zone.
- Put the smaller cookware on the smaller cooking zones.
- Put the cookware directly in the centre of the cooking zone.
- Use the residual heat to keep the food warm or to melt it.

14.3 Product Information and Product Information Sheet according to EU Ecodesign and Energy Labelling Regulations for ovens

Supplier's name	Electrolux
Model identification	LKR64440SW 947941545
Energy Efficiency Index	95.3
Energy efficiency class	A
Energy consumption with a standard load, conventional mode	0.95 kWh/cycle
Energy consumption with a standard load, fan-forced mode	0.82 kWh/cycle
Number of cavities	1
Heat source	Electricity
Volume	73 l

Type of oven	Oven inside Freestanding Cooker
Mass	56.7 kg

IEC/EN 60350-1 - Household electric cooking appliances - Part 1: Ranges, ovens, steam ovens and grills - Methods for measuring performance.

14.4 Oven - Energy saving



The appliance has features which help you save energy during everyday cooking.

Make sure that the appliance door is closed when the appliance operates. Do not open the appliance door too often during cooking. Keep the door gasket clean and make sure it is well fixed in its position.

Use metal cookware to improve energy saving.

When possible, do not preheat the appliance before cooking.

Keep breaks between baking as short as possible when you prepare a few dishes at one time.

Cooking with fan

When possible, use the cooking functions with fan to save energy.

Residual heat

When the cooking duration is longer than 30 min, reduce the appliance temperature to minimum 3 - 10 min before the end of cooking. The residual heat inside the appliance will continue to cook.

Use the residual heat to warm up other dishes.



Keep food warm

Choose the lowest possible temperature setting to use residual heat and keep a meal warm.

Moist Fan Baking

Function designed to save energy during cooking.

15. ENVIRONMENTAL CONCERNS

Recycle materials with the symbol . Put the packaging in relevant containers to recycle it. Help protect the environment and human health by recycling waste of electrical and electronic appliances. Do not dispose of appliances marked with the symbol  with

the household waste. Return the product to your local recycling facility or contact your municipal office.

Electrolux Appliances AB - Contact Address:
Al. Powstancow Slaskich 26, 30-570 Krakow,
Poland



electrolux.com

867363912-A-422023



CE